

23244

by UMB IJIMEAM

Submission date: 15-Sep-2024 08:15AM (UTC+0700)

Submission ID: 2454095577

File name: 23244-67564-1-CE.pdf (1,010.73K)

Word count: 6188

Character count: 30226

PLANNING AND FEASIBILITY STUDY OF A HYBRID SOLAR POWER PLANT WITH AN ADDED AUTOMATIC TRANSFER SWITCH (ATS) FOR AN OFFICE BUILDING

C. Buana*, M. Y. Yunus*, M. D. Abbas, R. Ashari, and N. S. I. Sari

Department of Mechanical Engineering, Politeknik Negeri Ujung Pandang, Tamalenrea, Makassar 90245, INDONESIA

Abstract

The Office of the Regent of Sidenreng Rappang (Sidrap), situated on Harapan Baru Street, Batu Lappa, Watang Pulu District, Sidrap Regency, South Sulawesi, consumes 200 kWh of electricity daily for lighting, resulting in substantial energy costs. Recognizing the potential for renewable energy, especially with a daily solar radiation potential of 5.8 kWh/m², this study proposes the implementation of a hybrid solar power plant system. The system incorporates Photovoltaic (PV) as the primary energy source, with the Grid and Generator serving as backup sources through an AC Coupling configuration utilizing Automatic Transfer Switch (ATS). The research employs a simulation approach using HOMER Pro software for system modeling, SketchUp software for solar panel layout, AutoCAD software for ATS circuit modeling, and theoretical calculations for financial analysis. The results indicate a solar power plant capacity of 39.6 kW, producing 75,701 kWh/year with an impressive 83.3% renewable penetration. From an economic standpoint, the project requires an investment of IDR 642,714,960, with a net present cost of IDR 1,573,177,823, and a cost of energy value of IDR 1,401.38/kWh. In terms of feasibility, the project demonstrates a net present value exceeding zero (IDR 216,680,041), a profitability index greater than one (1.33), an internal rate of return surpassing the credit interest rate (12.488%), and a payback period of 7 years and 7 months. These findings affirm the feasibility of the hybrid solar power plant planning project for the Sidrap Regent's Office, showcasing its economic viability and potential for sustainable energy solutions.

Keywords: Hybrid Power Plant, Automatic Transfer Switch, HOMER Pro, Solar PV, Office Building

*Corresponding author: Tel. +62 411 585365

E-mail address: chandra_buana@poliupg.ac.id, yunus_it@yahoo.com

DOI: 10.22441/ijimeam.v5i3.23244

1. Introduction

The escalating demand for electrical energy in Indonesia, fueled by population growth and technological advancements, has intensified the strain on traditional fossil fuel resources like oil, gas, and coal. Over-reliance on these resources depletes them rapidly and contributes significantly to environmental degradation, notably through the emission of greenhouse gases, a primary driver of global warming. The imperative for alternative and sustainable energy sources, such as wind, water, and solar power, has become paramount [1].

Endowed with abundant renewable energy resources, Indonesia boasts a potential exceeding 400,000 Mega Watts (MW), with solar energy alone constituting 50% or approximately 200,000 MW of this capacity. However, the current utilization is remarkably low, hovering around 150 MW, which is merely 0.08% of its potential [10]. To address this gap, the Indonesian government, under the auspices of the Ministry of Energy and Mineral Resources, has set an ambitious target to install 3,600 MW of Rooftop

Solar Power Plants by 2025, a strategic initiative outlined in the revision of the Minister of Energy and Mineral Resources Regulation No. 49 of 2018 [2].

The Regent's Office Building in Sidenreng Rappang (Sidrap) emerges as a significant consumer of electrical energy, averaging around 25,000 kWh per month or approximately 800 kWh per day. Notably, the lighting load alone accounts for about 200 kWh per day. The consequential monthly electricity expenditure incurred by the Sidrap Regency Government underscores the financial implications of conventional energy consumption. To mitigate these costs and align with national goals promoting renewable energy, exploring alternative energy sources, specifically harnessing solar power through a solar power plant, becomes imperative. This endeavor aims to optimize energy efficiency and aligns with broader governmental initiatives to foster sustainable and renewable energy practices.

A hybrid solar power plant represents an innovative approach integrating solar energy sources with multiple other energy inputs to achieve optimal



power generation. By amalgamating the strengths and mitigating the weaknesses of each energy generation system, hybrid solar power plants transcend the limitations of both on-grid and off-grid systems. This synthesis leverages diverse components such as batteries, the grid, and generators to create a comprehensive and efficient energy generation system [3].

In the context of planning a rooftop solar power plant for the North Tapanuli Regent's Office Building, it has been established that such a solar power plant holds the potential to generate 39.6 kWp of electrical power. HOMER simulation further reveals promising energy production data, indicating an annual output of 45,646 kWh from the PV system, contributing significantly to the electrical energy supply at a rate of 52.9% [4].

Additionally, research combining solar panel-generated electricity stored in batteries with grid electricity demonstrates the effectiveness of a hybrid solar power plant. This hybrid system contributes 39.3% of the electricity, with the remaining 60.7% sourced from the grid. The calculated payback period for this hybrid system is estimated to be 8 years and 7 months [5]. Moreover, in the study on the design of an Automatic Transfer Switch System in a Solar Cell-Grid Hybrid, notable power savings of 16.84% from the grid to the load were achieved under sunny weather conditions with 10 hours of exposure [6].

This present research endeavors to address the challenge of substantial monthly electricity bills at the Sidrap Regent's Office by proposing a solar power plant design that utilizes the entire roof area. The comprehensive approach considers technical, economic, and feasibility aspects, introducing novel elements not explored in prior research. These include three-dimensional PV layout planning, augmented renewable energy penetration, and the incorporation of Automatic Transfer Switch (ATS) components to enhance backup energy sources (grid generators). Through this multifaceted design, the study aspires to provide an effective and sustainable solution to the energy needs of the Sidrap Regent's Office.

2. Experimental Methods

2.1 Research Stages

Several stages need to be carried out in planning research for hybrid solar power plants. Research begins by selecting a location and conducting a preliminary study by collecting relevant information and data related to the research. The next process is to carry out modeling and simulation using HOMER software to produce technical aspects in the form of

energy production to compare the contribution of solar power, consumption from the grid, excess electricity, and renewable energy penetration.

Economic and feasibility aspects are carried out using theoretical calculations with financial analysis methods with input from HOMER software output.

The feasibility aspect of this research is the design performance evaluation aspect. Several standards in this planning are based on the economic price per kWh, Payback Period (BP) with a period shorter than the useful life, positive Net Present Value (NPV), Internal Rate of Return (IRR) greater than the credit interest rate, and Internal Rate of Return (PI) is greater than one. After all aspects have been obtained, the next step is to analyze and discuss the results.

The final stage of this research is designing the layout of the solar power plant using SketchUp software. After carrying out all these stages, conclusions and suggestions can be obtained from the research results.

2.2 Simulation

HOMER software is used to optimize and model hybrid systems by simplifying the task of evaluating various hybrid system configurations [7]. The results of this software simulation will recommend the most effective components used in power generation systems from both technical and economic aspects in projects over a long period. Therefore, this research will focus on modeling and simulation using HOMER software Pro to evaluate the potential and performance of a hybrid solar power plant system at the Sidrap regent's office [8].

The simulation process requires several input data and produces several outputs; more details can be seen in Figure 1.

2.3 Solar Power Plant System

In this research, a hybrid solar power generation

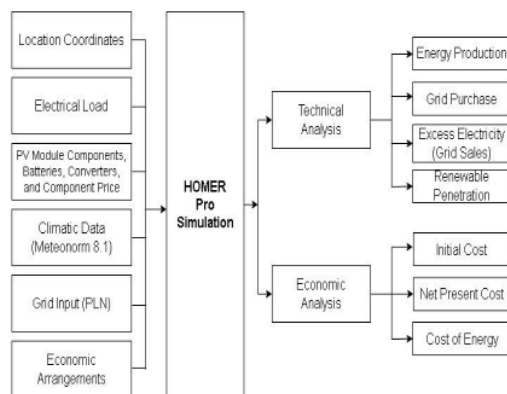

Fig. 1. HOMER simulation scheme

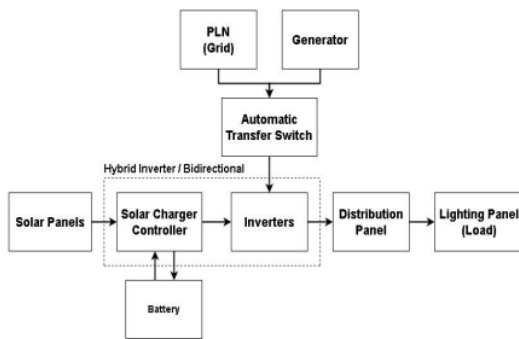

Fig. 2. Block diagram of the system

system will be designed by combining solar energy, batteries, grids, and generators. With this combination, it is hoped to save on electricity bills and increase the reliability of the hybrid solar power plant system by ensuring that a continuous supply of electricity is always ready for use.

However, this will experience problems if the reserved energy is not distributed smoothly and automatically. Therefore, adding an ATS system is necessary so that the system can work optimally, especially between the main backup source and additional backup, as shown in Fig. 2.

2.4 Economic Aspect

a. Initial Investment (capital cost)

The initial investment costs for the hybrid solar power generation system at the Sidrap Regent's Office include all component costs, supporting components, and mechanical and electrical work costs [9].

b. Operation & Maintenance Costs (O&M)

Fixed system operational and maintenance costs are annual costs by the generating system's size or configuration. It refers to installing and maintaining solar power generators, which account for 1-2% of the total investment costs. Operational and maintenance costs can be calculated using the following formula.

$$A = 1\% \times I_a \quad (1)$$

where:

A = maintenance cost (IDR)

I_a = total initial investment (IDR)

c. Life Cycle Cost (LCC)

The life cycle costs of a solar power generation system are determined from the initial investment costs, long-term costs of maintenance, operations,

equipment replacement (MPW), and the discount rate (i). So, it can be calculated using the formula below [10]:

$$M_{PW} = A \frac{(1+i)^n}{i(1+i)^n} - 1 \quad (2)$$

Project Period (years) Life cycle costs (LCC) are calculated using the following formula [11]:

$$LCC = C + M_{PW} \quad (3)$$

where:

M_{pw} = present value of annual costs over the life of the project (IDR)

A = annual fee (IDR)

i = discount rate or interest rate (%)

n = project age (years)

d. Cost of Energy (CoE)

Calculation of the energy costs of a solar power plant is determined by life cycle costs, capital recovery factor, and annual production kWh [12].

$$CRF = \frac{i(1+i)^n}{(1+i)^n - 1} \quad (4)$$

The Cost of Energy (CoE) for solar power plants is calculated using the following formula [12]:

$$CoE = \frac{LCC + CRF}{kWh_A} \quad (5)$$

where:

CRF = capital recovery factor (IDR)

i = discount rate (%)

n = period in years (investment age)

CoE = cost of energy (IDR/kWh).

kWh_A = annual energy generated (kWh/year).

2.5 Feasibility Aspect

a. Payback Period (PBP)

The payback period is the duration required for capital/investment to be returned. The payback period can be explained with the NPV curve or by using the following equation [13]:

$$PBP = \frac{\text{Initial Investment Capital}}{P} \quad (6)$$

Where P (profit) is the net profit for a year. Net profit is the sales value of electricity minus operation and maintenance costs (M) for one year. An investment is considered feasible if PBP < n or years of return on capital under the life of the project (n).



Table 1. Estimated daily electrical power needs for lighting

Construction	Equipment Name	Qty	Power (W)	Total Power (kW)	Usage Time (h)	Electrical Energy Consumption (kWh)
Building 1	LED Lights	78	24	1872	12	22.464
	Computers	32	50	1600	8	12.800
	CCTV	10	12	120	24	2.880
	Refrigerators	2	250	500	24	12.000
	Printers	12	30	360	2	720
	Televisions	6	75	450	5	2.250
	LED Lights	84	30	2520	24	60.480
Building 2	Computers	4	50	200	8	1.600
	CCTV	10	12	120	24	2.880
	Refrigerators	3	250	750	24	18.000
	Printers	5	30	150	2	300
	Televisions	3	75	225	5	1.125
	LED Lights	78	24	1872	12	22.464
	Computers	32	50	1600	8	12.800
Building 3	CCTV	10	12	120	24	2.880
	Refrigerators	2	250	500	24	12.000
	Printers	12	30	360	2	720
	Televisions	4	75	300	5	1.500
Electrical Terminal/Socket				3000	10	30.000
Total				13619		219.863

The further the life of the project, the greater the financial potential of the project.

1
 b. Net Present Value (NPV)

NPV states that all net cash flows are valued based on a discount factor. This technique calculates the difference between all net cash present value and the initial investment. The formula is given below [14].

$$\sum_{t=1}^n \frac{NCF_t}{(1+i)^t} - IA \quad (7)$$

where:

- 1** NCF_t = net cash flow for the period 1st year to nth year (IDR)
- n = age of investment (years)
- i = Interest rate (%)
- IA = Initial Investment (IDR)

8
 c. Internal Rate of Return (IRR)

IRR is the interest rate that equates the present value of an investment with the expected net results throughout the business. For the scenario of two previously known NPV values, IRR can be formulated as follows [14]:

$$IRR = ir \frac{NPV_r}{NPV_t - NPV_r} (it - ir) \quad (8)$$

5 here:

- 2** IRR = internal rate of return (%)

NPV_r = net present value with low interest rates (IDR)

NPV_t = Net Present Value with high interest rates (IDR)

- ir = low-interest rate (%)
- it = high-interest rate (%)

Where NPV_r must be above 0 (NPV_r > 0), NPV_t must be below 0 (NPV_t < 0).

d. Profitability Index (PI)

PI compares the financial value of data in the original investment, a metric used to determine whether a project or investment will generate profits.

The PI system is calculated using the following equation [15]:

$$PI = \sum_{t=1}^n \frac{NCF_t(1+i)^{-t}}{II} \quad (9)$$

where:

- 4** NCF_t = net cash flow for the period from year 1 to year n
- II = initial investment (IDR)
- 1** i = interest rate (%)

The criteria for determining whether an investment decision can be accepted or rejected are as follows:

- a. Investment is considered to be feasible if the PI is greater than one (>1).
- b. Investment is not feasible if the PI is less than one.



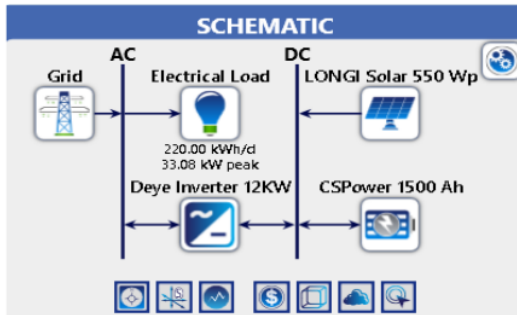

Fig. 3. Hybrid solar power plant design in HOMER Pro software



Fig. 4. Electrical energy production data from solar power plant system



Fig. 5. Results of energy storage in batteries

3. Results and Discussion

3.1 Electrical Energy Load Profile

The daily burden on the Sidenreng Rappang Regent's Office is the burden of consumption of electrical energy, specifically for lighting, which consists of the burden of lights, computers, CCTV, refrigerators, printers, and TVs. The use of energy loads in this research is based on estimates of lighting energy needs for 24 hours, with the aim that the use of lighting loads in the regent's office can be met

throughout the day. The estimated lighting load usage in the Sidenreng Rappang Regent's Office Building can be seen in Table 1.

The system design in the HOMER Pro software is carried out by combining several components that aim to help find a system that can optimize energy use and minimize dependence on fossil energy sources (grid). Using HOMER Pro software allows researchers to model, optimize, and monitor systems by considering several factors, namely, energy use, battery storage capacity, and characteristics of available resources.

This system has a total of 72 PV units with a total capacity of 39.6 kW, with 4 arrays (groups). Each array has 18 solar panels, with 6 arranged in series and 3 arranged in parallel. Each panel array has a capacity of 9.9 Wp, connected to 4 inverters, each with a capacity of 12 kW. The storage system uses 24 batteries arranged in series to get a system voltage of 48V; this system is also connected to the grid. Equipped with DC and AC protection systems, distribution panels, and ATS devices at backup sources.

3.2 Result of Technical Analysis of Homer Pro Software Simulation

a. Total Energy Produced

In Fig. 3 above, it can be seen that the electrical energy production from the designed solar power plant system is 75,701 kWh/year or 83.9% of annual electricity production, while for the grid, it is 14,566 kWh/year or 16.1% of electricity production annually. Based on these results, it can be concluded that the energy generated by solar power plants is higher than the grid.

b. Electrical Energy Stored by Batteries

In this system, there is a battery component as energy storage so that it can supply the load when the solar panels can no longer produce energy due to the absence of sunlight. In this system, the battery is capable of storing 75.8 kWh of energy while only 60.7 kWh is used because the battery discharge capacity limit or DOD is 80%. In the designed system, the energy stored in the battery is 15,023 kWh/year, and the energy output is 13,578 kWh/year with losses of 1,505 kWh/year. This can be seen in Fig. 5.

c. Grid Purchase

Grid Purchase is the purchase of electrical energy from the grid source as an additional energy source. The Purchase Grid can be seen in Fig. 6 below.



Month	Energy Purchased (kWh)	Energy Sold (kWh)	Net Energy Purchased (kWh)	Peak Load (kW)	Energy Charge Rp	Demand Charge Rp
January	1,250	873	377	24	Rp1,903,205.85	Rp0
February	1,418	422	997	21	Rp2,160,169.62	Rp0
March	1,662	458	1,205	18	Rp2,531,703.44	Rp0
April	1,134	433	700	24	Rp1,726,395.42	Rp0
May	1,251	367	883	16	Rp1,904,403.72	Rp0
June	1,697	218	1,479	21	Rp2,584,835.78	Rp0
July	1,012	398	613	16	Rp1,540,526.76	Rp0
August	928	643	285	14	Rp1,413,307.62	Rp0
September	1,015	829	186	17	Rp1,545,979.06	Rp0
October	760	650	110	13	Rp1,156,835.03	Rp0
November	1,022	857	165	22	Rp1,557,036.97	Rp0
December	1,417	593	824	17	Rp2,157,632.59	Rp0
Annual	14,566	6,740	7,825	24	Rp22,182,031.88	Rp0

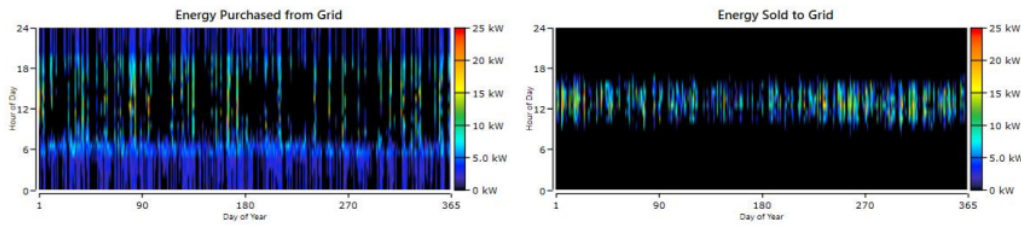

Fig. 6. Grid purchase

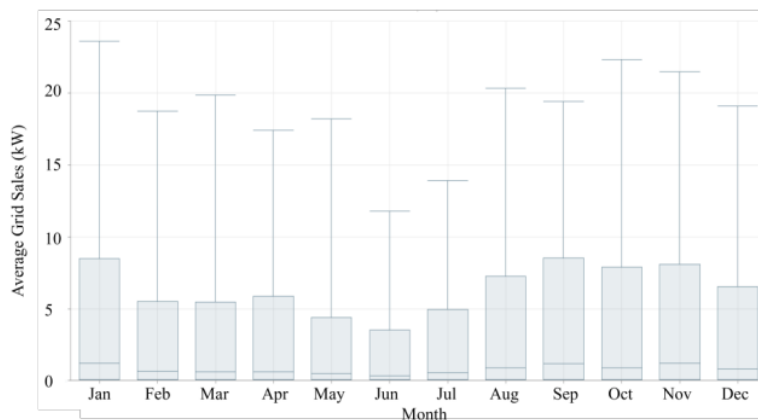

Fig. 7. Monthly sales grid graph

In Figure 5 above, the total energy supplied from the grid per year is 14,566 kWh/year, which is the largest energy use from the grid in June at 1,697 kWh/year.

d. Grid Sales

Grid Sales are excess energy produced by solar power plants and can no longer be transferred to batteries for storage. This energy can actually be exported to the grid, but with the latest policy, the grid no longer wants to buy excess energy produced by a system, so energy is wasted, and this can also be called Excess Electricity. This can be seen in Fig. 7 below.

In Fig. 7, the monthly sales grid, where the lowest average Grid Sales are in June at 0 to 5.04 kW per day, while the highest average Grid Sales were in September at 10.62 kW per day.

3.3 Automatic Transfer Switch (ATS)

a. ATS Control Circuit

This ATS control circuit works based on combinations of automatic switches, including relays and magnetic systems that are already available on the manufacturer's ATS device that will be used. It can be described more clearly below.

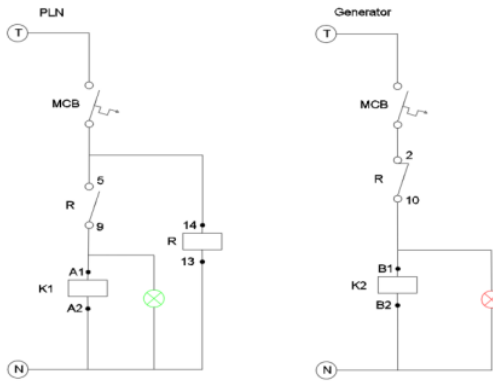

Fig. 7. Control circuit on ATS

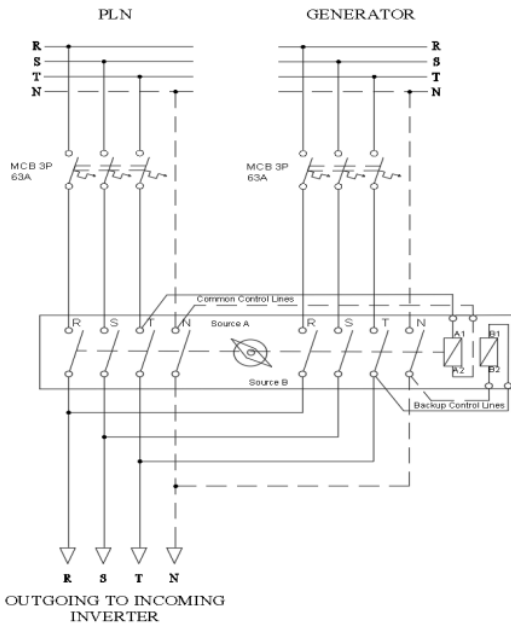

Fig. 8. Power circuit on ATS

b. ATS Power Circuit

The ATS system works automatically and is integrated to prevent interference or flickering when the system is automatically operated. Flicker refers to repeated voltage fluctuations or unstable electrical power supply that can cause interference or damage to sensitive electronics.

By using the ATS device, switching between grid resources and generator resources can be used automatically and responsively with a switching speed of less than one second. Faster switching times can be achieved by reducing fluctuations and instability in the power supply to minimize the possibility of flickering.

3.4 Economic Analysis

a. Operation & Maintenance Cost

The total cost calculation is the total incurred during the operation and maintenance period of the Hybrid solar power plant system each year.

Table 2. Total initial investment

No	Component	Qty	Unit Price (IDR)	Subtotal (IDR)
A. Main Component				
1	Solar Panel 550 Wp	72	2,700,000	194,400,000
2	Inverter 12 kW	4	27,350,000	109,400,000
3	Battery 2V 1500 Ah	24	6,650,000	159,600,000
4	ATS Device	1	415,000	415,000
Total Price A				463,815,000
B. DC Protection Device				
1	Panel Box	1	90,000	90,000
2	NT Fuse 35A	4	25,000	100,000
3	MCB DC 40A	4	56,000	224,000
4	Arrester SPD 500V	4	145,000	580,000
Total Price B				994,000
C. AC Protection Device				
1	Panel Box 20x17x12	4	90,000	360,000
2	Panel Box 40x50x18	2	203,000	430,000
3	MCB AC 50A	8	95,000	760,000
4	MCB AC 32A	8	85,000	680,000
5	MCB AC 63A	3	95,000	285,000
6	Arrester SPD	4	222,740	500,960
Total Price C				3,381,960
D. Cable				
1	NYAF 1x16 mm	4 roll	1,700,000	6,800,000
2	NYAF 1x95 mm	10 m	170,000	1,700,000
3	NYHY 3x16 mm	100 m	120,000	12,000,000
Total Harga D				20,500,000
E. Other Components				
1	Concrete	6	150,000	900,000
2	Rail AL6005-T5	125 m	225,000	28,125,000
3	End Clamp	36	15,000	540,000
4	Mid Clamp	126	15,000	1,890,000
5	Tile Roof Hook	36	85,000	3,060,000
6	Copper Busbars	22	50,000	1,100,000
7	Din Rail	4	17,000	68,000
8	Grounding Rod 1.5 m	2	55,000	110,000
9	Duct Cable	15 m	8,000	120,000
10	Pilot Lamp	2	25,000	50,000
11	Tiger Nail Clamps	2	22,000	44,000
12	MC4 Connector	12	40,000	480,000
13	Copper Grounding Bar	2	36,000	72,000
14	Installation Services	39.6kW	3,000,000	118,800,000
Total Price E				154,495,000
Initial Investment				643,149,960

The operational costs of a solar power plant can be calculated according to the age of the components used using the following calculation.

Note = 2 inverter changes
 Inverter Price = 109,400,000 (27,300,000 x 4)
 Operational Costs = 2 x IDR 109,400,000
 = IDR 218,800,000

The annual maintenance costs for the Hybrid solar power plant system are calculated using the following equation:

Maintenance Fee = 2% x Initial Investment
 = 2% x IDR 643,149,960
 = IDR 12,862,999

Grid purchase costs can be calculated based on the selling price of the grid per year, where the annual



purchase cost from the grid is IDR. 1,552.88/kWh using the following calculation.

$$\begin{aligned} \text{Total Grid purchases} &= 14,566 \text{ kWh/year} \\ \text{Price Per KWh} &= \text{IDR } 1,552.88 \\ \text{Purchase Cost} &= 14,566 \times \text{IDR } 1,552.88 \\ &= \text{IDR } 22,619,250 \end{aligned}$$

So, the total operational costs and Maintenance of a hybrid solar power plant in a year equals IDR 35,482,250; this cost does not include solar power plant operational costs, which is the cost of replacing components, IDR 218,800,000. And for unexpected costs obtained from a value of 2% multiplied by the initial investment cost has a return of IDR 12,862,999/year, where the project life is 25 years. So the result is a value of IDR 12,862,999/year multiplied by project life for 25 years, amounting to IDR 321,574,975.

b. Life Cycle Cost

The planning for this hybrid solar power plant can run for 25 years, based on the lifetime of the solar panels used. Meanwhile, the interest rate used in this planning is 8.43%, so it can be calculated using the following equation:

Is known that Operational & Maintenance Costs (A) = IDR 35,482,250, and n = 25 years.

$$\begin{aligned} M_{PW} &= A \left[\frac{(1+i)^n - 1}{i(1+i)^n} \right] \\ &= \text{IDR } 5,482,250 \left[\frac{(1+0.0843)^{25} - 1}{0.0843(1+0.0843)^{25}} \right] \\ &= \text{IDR } 35,482,250 \times 10.28 \\ M_{PW} &= \text{IDR } 364,757,522 \end{aligned}$$

So, the fixed costs of maintenance over a 25-year service life can be determined by the LCC value as follows.

$$\begin{aligned} LCC &= CT + MPW \\ &= (\text{IDR } 643,149,960 + \text{IDR } 218,800,000) + \\ &\quad \text{IDR } 364,757,522 \\ &= \text{IDR } 1,226,707,482 \end{aligned}$$

From the calculation above, the LCC value for a hybrid solar power plant is IDR 1,226,707,482.

c. Cost of Energy

Before calculating COE, a calculation is carried out to obtain the Capital Recovery Factor (CRF) value. CRF is used to convert all cash flows from life cycle costs into a series of annual costs that can be calculated using the equation.

$$CRF = \frac{i(1+i)^n}{(1+i)^n - 1}$$

$$\begin{aligned} &= \frac{0.0843(1+0.0843)^{25}}{(1+0.0843)^{25} - 1} \\ &= \frac{0.638}{6.564} \\ &= 0.097 \end{aligned}$$

From the calculation results of the LCC, CRF values and the amount of energy produced per year, it is obtained that it is 80,300 kWh/year, which makes it possible to carry out calculations to determine the COE value, which can be calculated using the following equation:

$$\begin{aligned} COE &= \frac{LCC \times CRF}{A \text{ KWH}} \\ &= \frac{\text{IDR } 1,226,707,482 \times 0.097}{80,300} \\ &= \text{IDR } 1,481.83/\text{kWh} \end{aligned}$$

3.5 Feasibility Analysis

a. Payback Period

$$\begin{aligned} \text{Cash Inflow} &= \text{Total energy consumption} \times \\ \text{Electricity selling price} &= 80,300 \text{ kWh} \times 1,401.96/\text{kWh} \\ &= \text{IDR } 112,577,392/\text{year} \end{aligned}$$

$$\begin{aligned} \text{Cash Outflow} &= \text{PV Maintenance} + \text{Grid Purchase} \\ &= 12,862,999 + 22,619,250 \\ &= \text{IDR } 35,482,250/\text{year} \end{aligned}$$

$$\begin{aligned} \text{Net Income} &= \text{Cash Inflow} - \text{Cash Outflow} \\ &= 112,577,392 - 29,050,750 \\ &= \text{IDR } 83,526,642/\text{year} \end{aligned}$$

b. Net Present Value

The NPV calculation requires the sum of investment costs, cash inflows, and outflows, and a discount factor.

Table 3 shows that the total present value of net cash flow resulting from multiplying net cash flow with a discount factor is IDR 859,829,226 if the initial investment is IDR. 643,149,960, then the NPV can be calculated as follows:

$$\begin{aligned} NPV &= \sum_{t=1}^n \frac{NCF_t}{(1+i)^t} - IA \\ &= 859,829,226 - 643,149,960 \\ &= \text{IDR } 216,679,266 \end{aligned}$$

c. Internal Rate of Return

In determining the IRR value when NPV = 0, the interpolation method can be used between interest rates that produce positive NPV and negative NPV. Where the low-interest rate used is 7%, and the high-interest rate used is 13%.

Table 3. Net present value

Year	Net Present Value			
	Initial Investment (IDR)	NCF (IDR)	DF	PVNCF (IDR)
0	258.290.000		1	643,149,960
1		83,526,642	0.922	77,032,779
2		83,526,642	0.851	71,043,787
3		83,526,642	0.784	65,520,416
4		83,526,642	0.723	60,426,465
5		83,526,642	0.667	55,728,549
6		83,526,642	0.615	51,395,876
7		83,526,642	0.567	47,400,052
8		83,526,642	0.523	43,714,887
9		83,526,642	0.483	40,316,229
10		83,526,642	0.445	37,181,803
11		83,526,642	0.411	34,291,066
12		83,526,642	0.379	31,625,072
13		83,526,642	0.349	29,166,349
14		83,526,642	0.322	26,898,782
15		83,526,642	0.297	24,807,509
16		83,526,642	0.274	22,878,824
17		83,526,642	0.253	21,100,087
18		83,526,642	0.233	19,459,639
19		83,526,642	0.215	17,946,730
20		83,526,642	0.198	16,551,443
21		83,526,642	0.183	15,264,634
22		83,526,642	0.169	14,077,870
23		83,526,642	0.155	12,983,372
24		83,526,642	0.143	11,973,966
25		83,526,642	0.132	11,043,038
TOTAL				859,829,226
DISKONTO ANNUITIES				10,294

Table 4. Low interest rate 7% & high interest rate 13%

Year	Net Present Value				
	NCF (IDR)	DF (7%)	PVNCF (IDR)	DF (13%)	PVNCF (IDR)
0		1	643.149.960	1	643.149.960
1	83.526.642	0.935	78.062.282	0.885	73.917.382
2	83.526.642	0.873	72.955.404	0.783	65.413.613
3	83.526.642	0.816	68.182.621	0.693	57.888.153
4	83.526.642	0.763	63.722.075	0.613	51.228.454
5	83.526.642	0.713	59.553.341	0.543	45.334.915
6	83.526.642	0.666	55.657.328	0.480	40.119.394
7	83.526.642	0.623	52.016.195	0.425	35.503.888
8	83.526.642	0.582	48.613.266	0.376	31.419.370
9	83.526.642	0.544	45.432.959	0.333	27.804.752
10	83.526.642	0.508	42.460.709	0.295	24.605.975
11	83.526.642	0.475	39.682.906	0.261	21.775.200
12	83.526.642	0.444	37.086.828	0.231	19.270.088
13	83.526.642	0.415	34.660.587	0.204	17.053.175
14	83.526.642	0.388	32.393.072	0.181	15.091.306
15	83.526.642	0.362	30.273.899	0.160	13.355.138
16	83.526.642	0.339	28.293.363	0.141	11.818.706
17	83.526.642	0.317	26.442.396	0.125	10.459.032
18	83.526.642	0.296	24.712.519	0.111	9.255.780
19	83.526.642	0.277	23.095.813	0.098	8.190.956
20	83.526.642	0.258	21.584.872	0.087	7.248.634
21	83.526.642	0.242	20.172.777	0.077	6.414.720
22	83.526.642	0.226	18.853.063	0.068	5.676.743
23	83.526.642	0.211	17.619.685	0.060	5.023.667
24	83.526.642	0.197	16.466.995	0.053	4.445.723
25	83.526.642	0.184	15.389.715	0.047	3.934.268
Total			973.384.670		612.249.031
NPV			330.234.710	NPV	-30.900.929
Diskonto Annuities			11,654		7,330

From the table above, the data as shown in Table 4 below is then calculated using the following equation:

$$IRR = Ir + \left(\frac{NPVr}{NPVr - NPVt} \right) (It - Ir)$$

$$= 7\% + \left(\frac{330,234,470}{330,234,710 - (-30,900,929)} \right) (13\% - 7\%)$$

$$= 12,487\%$$

Based on the calculations outlined above, an Internal Rate of Return (IRR) value of 12.487% is attained. This figure surpasses the deposit interest rate of 8.43%, affirming the feasibility of implementing a Hybrid Solar Power Plant at the Sidenreng Rappang Regent's Office.

3.6 Layout in 3D

Planning for the Hybrid Solar Power Plant system was carried out by redrawing the layout of the placement of components such as solar panels, inverters and batteries, as well as various other components using Sketchup Pro software. An image of this planning layout in 3D form can be seen in the following image.



Fig. 9. Hybrid solar power plant layout design for Sidenreng Rappang Regent's Office Building

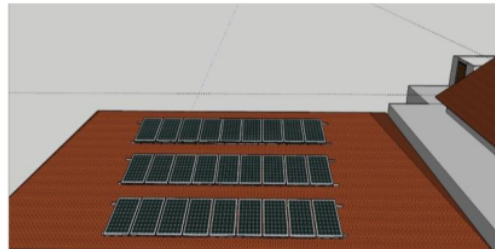

Fig. 10. Roof side PV layout design

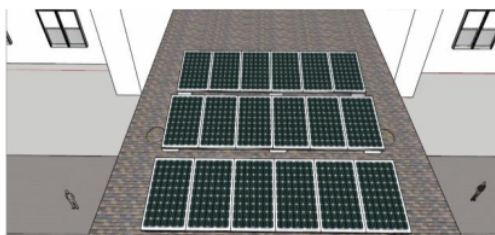

Fig. 11. Rooftop side PV layout design



Fig. 12. Electrical system room layout design

4. Conclusions

The simulation results conducted through HOMER Pro software offer a comprehensive overview of the potential electrical energy output of the solar power plant. The data indicates an annual production capacity of 75,701 kWh, with a substantial portion of this energy, amounting to 83.9%, contributed by the Solar Power Plant, and the remaining 16.1% sourced from the grid. This underscores the effectiveness of the hybrid system in leveraging solar energy to meet a significant portion of the energy needs.

However, an aspect of concern arises in the form of excess energy amounting to 6,740 kWh/year, which is channeled back to the grid and categorized as wasted energy. This surplus energy signifies a missed opportunity for further optimization or storage. As the Hybrid Solar Power Plant excels in generating substantial energy, strategies to harness and store surplus energy could be explored to minimize wastage and enhance the overall efficiency of the system. While the Hybrid Solar Power Plant demonstrates commendable performance in meeting a considerable portion of the energy demand, attention to strategies for managing excess energy could enhance the sustainability and efficiency of the system. Future considerations might involve the integration of storage solutions or alternative applications for surplus energy to further maximize the benefits of this hybrid energy generation system.

5. Acknowledgements

The author expresses gratitude to the Department of Mechanical Engineering, Politeknik Negeri Ujung Pandang, for its invaluable support. Special thanks are extended to all the staff and employees of the Sidenreng Rappang Regent's Office for granting permission and providing support for this research.

References

[1] Mahesa, A. G., & Khwee, K. H. (2021). Studi perencanaan pembangkit listrik tenaga surya sistem hybrid sebagai sumber energi

alternatif. *Jurnal Teknik Elektro Universitas Tanjungpura*, 2(1).

- [2] Direktorat Jenderal EBTKE (2021). Indonesia kaya energi surya, pemanfaatan listrik tenaga surya oleh masyarakat tidak boleh ditunda. <https://www.esdm.go.id/id/media-center/arsip-berita/indonesia-kaya-energi-surya-pemanfaatan-listrik-tenaga-surya-oleh-masyarakat-tidak-boleh-ditunda>
- [3] Albeni, F. (2022). *Perancangan sistem pembangkit listrik hybrid tenaga surya dan PLN* [Thesis]. Universitas Muhammadiyah Sumatera Barat.
- [4] Silaban, I. O., Kumara, I. N. S., & Setiawan, I. N. (2021). Perancangan PLTS atap pada gedung kantor bupati tapanuli utara dengan arsitektur rumah adat Batak Toba. *Jurnal Spektrum*, 8(2).
- [5] Sudarjo, N. H., Haddin, M., & Suprajitno, A. (2022). Analisa perencanaan pembangkit listrik tenaga surya atap dengan sistem hybrid di PT. Koloni Timur. *Elektrika*, 14(1), 20-25.
- [6] Audia, W., Yulkifli, Y., Mairizwan, M., & Rinaldi, A. (2022). Automatic transfer switch system design on solar cell-grid hybrid based on Android application. *EKSAKTA: Berkala Ilmiah Bidang MIPA*, 23(04), 266-283.
- [7] HOMER Energy (2011). *Getting Started Guide for HOMER Legacy (Version 2.68)*. Homer Energy and National Renewable Energy Laboratory, Colorado.
- [8] Navies, A. (2021). *Analisis teknis dan ekonomi pembangkit listrik tenaga hybrid biomass-biogas* [Thesis]. Universitas Islam Negeri Sultan Syarif Kasim.
- [9] Bagaskoro, B., Windarta, J., & Denis, D. (2019). Perancangan dan analisis ekonomi teknik pembangkit listrik tenaga surya sistem offgrid menggunakan perangkat lunak Homer di Kawasan Wisata Pantai Pulau Cemara. *Transient: Jurnal Ilmiah Teknik Elektro*, 8(2), 152-157.
- [10] Wibowo, R. E. A., Tumaliang, H., & Rumbayan, M. (2022). *Perencanaan sistem hybrid pada jaringan kelistrikan di Rumah Sakit Monompia Kotamobagu* [Thesis]. Universitas Sam Ratulangi.
- [11] Michael Pamingotan Sitohang, M. (2019). *Perancangan pembangkit listrik tenaga surya (PLTS) terpusat off-grid system (Studi kasus: Desa Tanjung Beringin, Kabupaten*

- Kampar, Riau* [Thesis]. Universitas Islam Negeri Sultan Syarif Kasim Riau.
- [12] Riskawati, R. (2022). *Studi perencanaan sistem tenaga listrik hybrid untuk penerapan daerah terisolir (Studi kasus: Pulau Barrang Lompo)* [Theis]. Universitas Hasanuddin.
- [13] Asrori, A., dkk. 2022. Kajian Kelayakan Solar Rooftop On-Grid untuk Kebutuhan Listrik Bengkel Mesin di Polinema. *ELKOMIKA: Jurnal Teknik Energi Elektrik, Teknik Telekomunikasi, & Teknik Elektronika*, 10(4), 830.
- [14] Fachrezy, M. D. (2022). *Pembangkit listrik tenaga surya (PLTS) terpusat off-grid di desa terpencil Kabupaten Indragiri Hulu* [Thesis]. Universitas Islam Negeri Sultan Syarif Kasim Riau.
- [15] Chandra, Y. (2016). Analisis ekonomi energi perencanaan pembangunan PLTS (Studi kasus gedung kuliah Politeknik Negeri Ketapang). *Jurnal ELKHA Vol*, 8(1).

ORIGINALITY REPORT

17%

SIMILARITY INDEX

14%

INTERNET SOURCES

13%

PUBLICATIONS

7%

STUDENT PAPERS

PRIMARY SOURCES

1	Chaerul Muzakkir, Fitriah Fitriah, M. Iqbal Arsyad. "STUDY OF HYBRID ELECTRICAL SYSTEM PLANNING IN THE RESEARCH AND COMMUNITY SERVICE INSTITUTE BUILDING", Telecommunications, Computers, and Electricals Engineering Journal, 2023 Publication	3%
2	Submitted to Universitas Bangka Belitung Student Paper	3%
3	Submitted to Universitas Mercu Buana Student Paper	2%
4	jurnal.untan.ac.id Internet Source	2%
5	repository.poliupg.ac.id Internet Source	2%
6	listens.online Internet Source	1%
7	M.O. Ojumu, A.K. Raji. "Structural frame analysis of an electrically powered robotic subsea dredging crawler under static loading	1%

conditions", Journal of the Southern African
Institute of Mining and Metallurgy, 2023

Publication

8	elibrary.tucl.edu.np Internet Source	<1 %
9	scholar.google.co.id Internet Source	<1 %
10	jurnalindustri.petra.ac.id Internet Source	<1 %
11	Submitted to Tzuchi Secondary School Student Paper	<1 %
12	Syafii Syafii, Wati Wati, Rahmad Fahreza. "Techno-economic-enviro optimization analysis of diesel/PV/wind with pumped hydro storage for Mentawai Island microgrid", Bulletin of Electrical Engineering and Informatics, 2021 Publication	<1 %
13	eksakta.ppj.unp.ac.id Internet Source	<1 %
14	1library.net Internet Source	<1 %
15	dinarek.unsoed.ac.id Internet Source	<1 %
16	wiki.doing-projects.org Internet Source	<1 %

Exclude quotes On

Exclude matches < 17 words

Exclude bibliography On

23244

GRADEMARK REPORT

FINAL GRADE

GENERAL COMMENTS

/100

PAGE 1

PAGE 2

PAGE 3

PAGE 4

PAGE 5

PAGE 6

PAGE 7

PAGE 8

PAGE 9

PAGE 10

PAGE 11
